

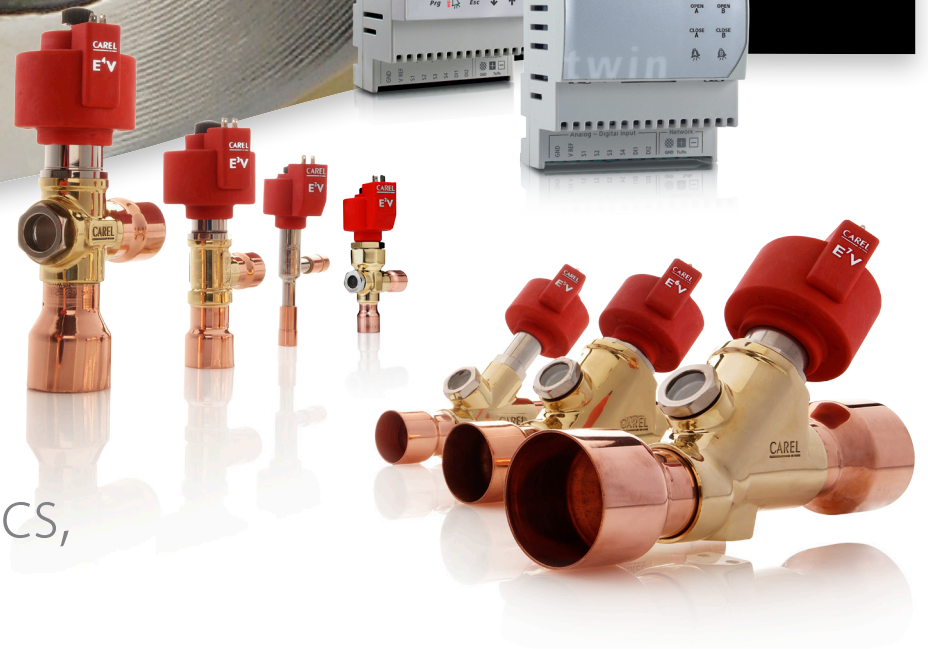

connectivity, monitoring and remote management systems  
electronic expansion valves and drivers



## E<sup>x</sup>V sistema

Precision mechanics,  
powerful control

# E<sup>X</sup>V sistema - a complete range of electronic valves for HVAC/R applications

With E<sup>X</sup>V istema CAREL offers a complete and integrated solution for controlling evaporation temperature in air-conditioning and refrigeration units, through the E<sup>X</sup>V electronic expansion valves and the new EVD evolution superheat controller.

2000 kW

maximum cooling capacity: model E<sup>V</sup> with R407C refrigerant, t condensing= 38 °C (100.4 °F), t evaporating= 4,4 °C (39.92 °F), subcooling 1°C (1.8 °F)

10 years

experience in the development of control systems and superheat control valves

100%

of valves tested after production

This solution is the result of decades of experience in the specific application, and thanks to the new EVD evolution driver, it integrates perfectly into the series of CAREL controllers for the optimised management of the complete refrigeration cycle. Today CAREL offers a complete range of electronic valves for cooling capacities up to 2000 kW, covering the needs of all HVAC/R applications.

All valves share the same features and construction technology.



## Energy saving

Operation at minimum possible condensing pressure means less work performed by the compressor, and a consequent reduction in energy consumption.



## Easy to use

Quick start with just 4 settings, graphic display with help on the parameters, easy driver and valve installation and maintenance.



## CO<sub>2</sub> Ready

CAREL control systems and E<sup>X</sup>V valves can manage both subcritical and transcritical CO<sub>2</sub> cycles.

**E<sup>2</sup>V** 40 kW\*    **E<sup>3</sup>V** 140 kW\*    **E<sup>4</sup>V** 280 kW\*    **E<sup>5</sup>V** 600 kW\*    **E<sup>6</sup>V** 1300 kW\*    **E<sup>7</sup>V** 2000 kW\*

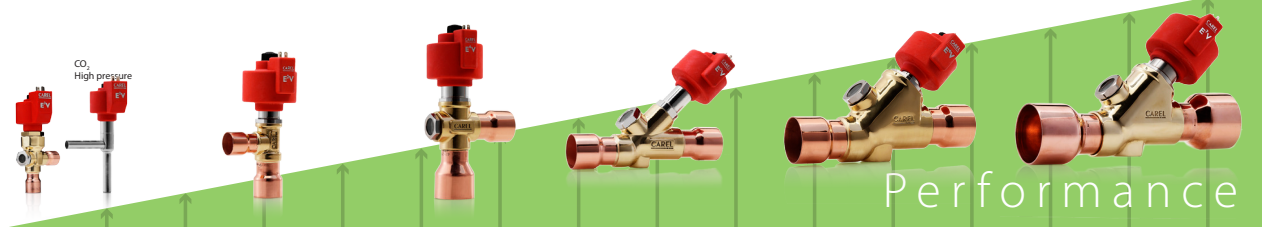

Capacity kW

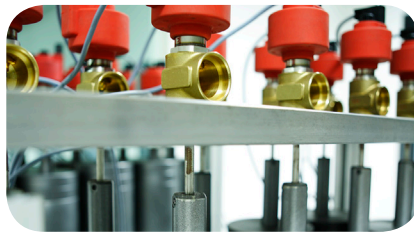

CAREL E<sup>V</sup> valves have been lifetime tested in the most critical operating conditions by the CAREL labs

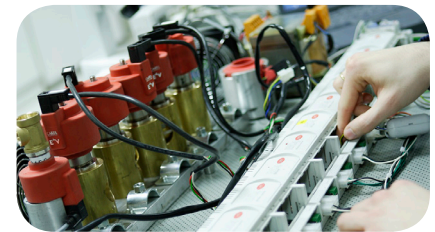

CAREL accepts no compromises in the quality of its products: at the end of the production process, each valve undergoes functional tests and is checked for refrigerant leaks.

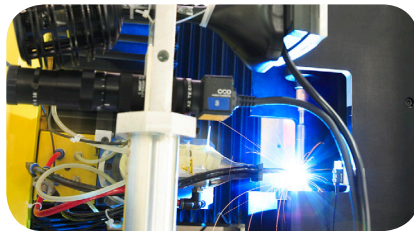

The E<sup>V</sup> range has been designed in-house at the CAREL labs and is manufactured and assembled at the Group's facilities using the most advanced technology.

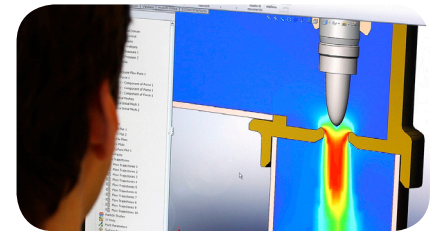

The CAREL labs conduct ongoing research into innovative solutions for optimising the performance of the E<sup>V</sup> valves, using computerised simulation techniques.



### Performance

Sophisticated control functions (LOP, MOP, Low SH, transcritical CO<sub>2</sub>,...) and construction with advanced materials for optimum management of refrigerant flow, even in the most critical conditions.



### Multilanguage

System easy to understand and configure, with 10 languages available, in addition to English (always available).



### Reduced environmental impact

Compatibility with natural refrigerants (CO<sub>2</sub>) and energy saving help reduce ozone layer depletion and greenhouse gas emissions.



# E<sup>X</sup>V series valves & EVD evolution driver

The range of electronic expansion valves offered by CAREL covers cooling capacities up to 2000 kW, thanks to the new E<sup>7</sup>V series. All CAREL valves share the same technological solutions, from the larger sizes (E<sup>5</sup>V, E<sup>6</sup>V, E<sup>7</sup>V) to the high-end solution for 40 kW (E<sup>2</sup>V smart).

## Valve features

The main features of the E<sup>X</sup>V valves are:

- external stator replaceable without dismantling the valve;
- removable motor mechanism (except for model E<sup>2</sup>V) to assist soldering and replacement without unsoldering the valve;
- Integrated flow indicator (except for models E<sup>2</sup>V & E<sup>3</sup>V);
- gearless
- movement on stainless steel ball bearings;
- tight when valve closed;
- control with flow in both directions;
- equipercetile variation of refrigerant flow-rate: ensures high precision control at low flow-rates

## The new EVD evolution driver

The new EVD evolution driver has been enhanced with advanced functions and a new user interface that makes it even easier to use and configure:

- superheat control with auxiliary high pressure, low pressure and low superheat protection;
- start-up with just 4 parameters: refrigerant used, model of valve, type of pressure sensor and application (chiller, showcase, etc.);
- new battery module;
- Twin version to control two valves;
- self-adaptive algorithm;
- algorithm for Digital Scroll applications;
- connection diagram visible on the display;
- removable multi-language graphic display, with "help" on the parameters
- multiple units of measure (metric or Imperial);
- user management with passwords for accessing different levels of configuration;
- copy parameter values to other EVDs using the display;

- LEDs for monitoring the main parameters;
- use of ratiometric or 4 to 20 mA transducers (the latter can be shared between multiple drivers);
- second digital input for defrost management;
- possibility to use backup sensors;
- serial communication protocols: CAREL-master, pLAN Modbus®.

The new TWIN version can independently control two electronic expansion valves, and represents the ideal solution for two circuit units or different control functions (i.e. superheat and hot gas bypass). Connected to a pCO series controller, EVD Evolution can manage superheat on units fitted with Digital Scroll compressors, using a specific algorithm patented by CAREL and approved by Emerson Climate Tech.

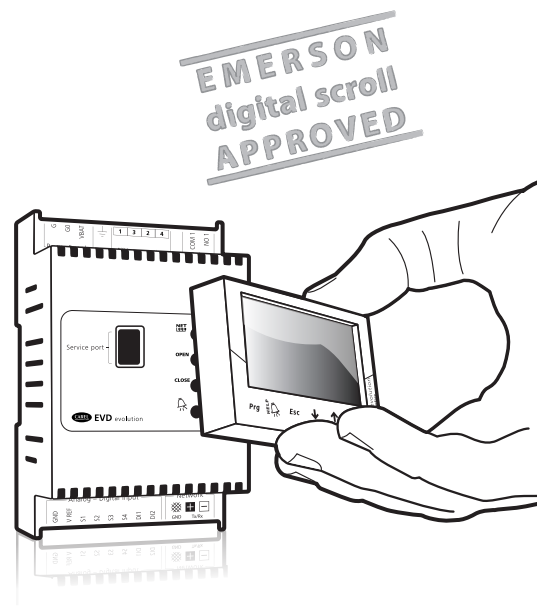

# E<sup>2</sup>V smart - high technology for even more flexible operation

The CAREL E<sup>2</sup>V-smart series electronic expansion valves combine the renowned reliability of the CAREL E<sup>2</sup>V with the versatility of a removable cartridge, covering a range of cooling capacities from 1 kW to 40 kW.

Modulation of refrigerant flow guarantees a wide operating range, due to the combination of the fixed opening and the moving element with a travel of 15 mm driven by stepper motor.

The E<sup>2</sup>V-smart has been carefully designed down to the smallest detail, to guarantee high reliability, and ensures correct operation with fluid flow in both directions. This simplifies the refrigerant circuit for reverse-cycle operation and reduces installation costs.

E<sup>2</sup>V-smart is made from modular components that are assembled during installation; this solution simplifies maintenance and inspection of the individual components.



- efficient control of refrigeration and air-conditioning units, over an extended range of applications;
- completely removable for extremely simple installation;
- high reliability and high quality materials;
- equipercetile profile: guarantees precise control even when operating at part load.

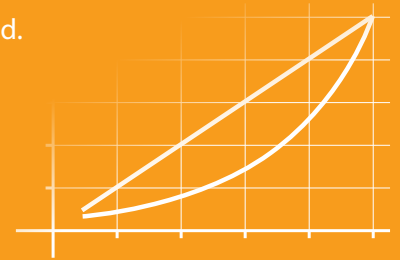

## Components

### Removable stator

Easy to install and no contact with the refrigerant.

### Removable cartridge

Guarantees maximum flexibility in installation, thanks to the possibility to weld the valve body separately from the cartridge.

### Teflon gasket

Guarantees perfect seal when valve closed

### Built-in filter

Optional. Easy management of refrigerant filtering

### Add-on sight glass

Optional. Shows the movement of the valve and the quality of expansion

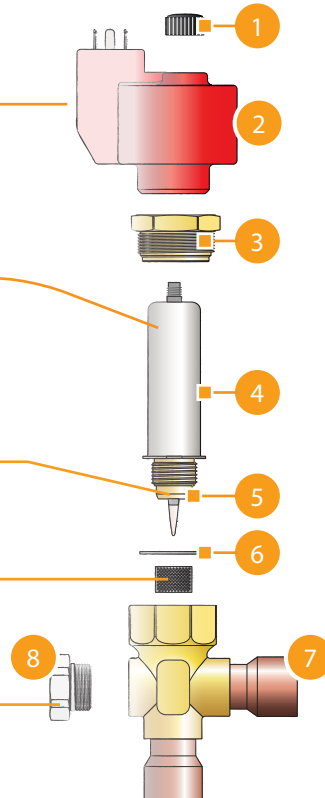

- 1 threaded cap;
- 2 resin-bonded stepper motor with connector pins;
- 3 ring nut;
- 4 removable cartridge with kinematic mechanism and movement (control rod);
- 5 Teflon seal gasket;
- 6 Teflon gaskets;
- 7 body with fittings to be welded to the circuit pipework;
- 8 threaded sight glass with 2 o-rings (optional).

# CAREL integrated systems for all applications

CAREL controllers offer native support in managing all the main applications of the electronic valve system.

## Retail

The new MPXPRO family controllers for showcases can be fitted with a built-in driver for controlling CAREL EXV valves. In supermarket applications, all the MPXPRO controllers interface to CAREL supervisory systems so as to guarantee complete control of the installation.



## Air-conditioning

the complete range of CAREL EXV valves is suitable for all refrigeration units up to 2000 kW; in addition, integration between EVD evolution and the pCO series programmable controllers ensures optimised control of the entire refrigeration system and sharing of data with CAREL supervisory systems.



## Stand-alone

the EVD driver evolution can independently control the CAREL EXV valves (stand-alone mode), using just one digital input for activation. This solution is suitable for any refrigerant circuit, regardless of the controller used.



### Driver application example

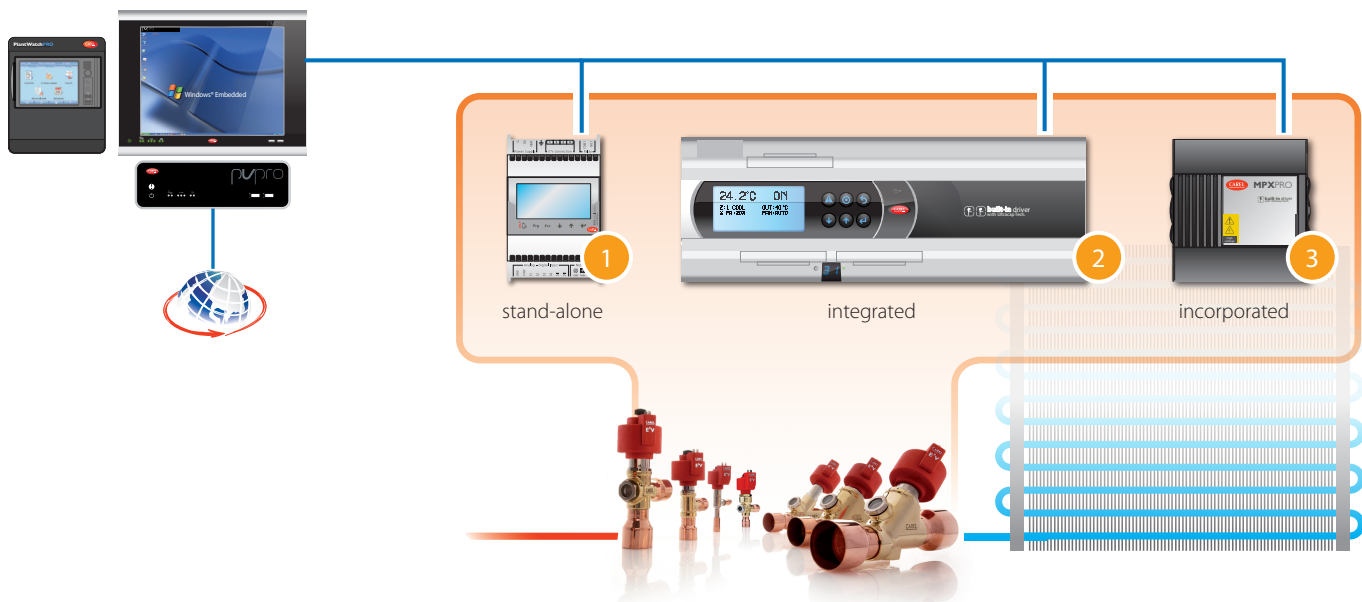

- 1 Driver valvola caratterizzato da:
  - just 4 parameters to be set (refrigerant, valve, sensor, type of application);
  - removable, multi-language graphic LCD, with metric or Imperial units of measure;
  - independent control of up to 2 valves;
  - Modbus® or CAREL protocols available.

- 2 pCO programmable controller with EVD Evolution valve driver:
  - exchanges information and alarms to optimise control of the system;
  - uses a single user interface to configure and monitor the entire system;
  - allows easy development of custom software using CAREL 1 tool.

- 3 MPXPRO controller with built-in valve driver:
  - floating evaporation pressure control;
  - modulating temperature control;
  - integration of showcase control with;
  - EEV control functions

# Energy saving: our future

Electronic valves optimise flow in the refrigerant circuit in all operating conditions. As a result, significant energy savings can be achieved by installing these valves

## -14.3%

energy saving by reducing power consumption in chiller applications

One of the main advantages in using E<sup>V</sup> technology is the energy saving achievable due to improved efficiency of the refrigeration cycle. The possibility to operate at low superheating pressures, as well as precise superheat control, allow considerable energy saving: the advantages have been proven and validated in the field, in both refrigeration and air-conditioning applications, and guarantee extremely short payback times compared to standard mechanical technology.

### energy consumption \*

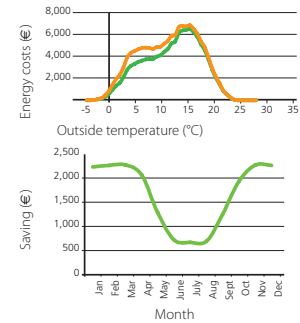
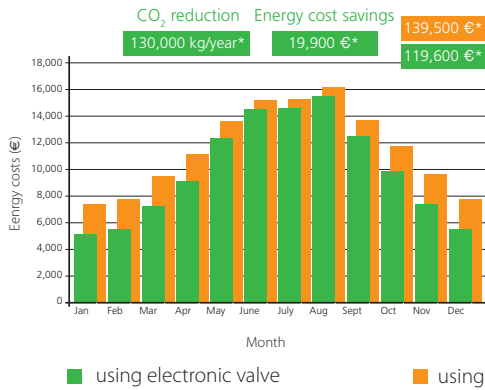

\*Measurements carried out in a telephone exchange air-conditioning system, operating with six two-circuit chillers on R22, maximum capacity 900 kW

## -30%

energy saving by reducing power consumption in supermarket applications

The field trials were performed installing a CAREL E<sup>V</sup> valve and a traditional thermostatic valve in parallel, and then activating these alternately and monitoring energy consumption and cooling efficiency during operation with each valve. This has provided concrete proof of the savings achievable using CAREL E<sup>V</sup> technology.

### energy consumption \*\*

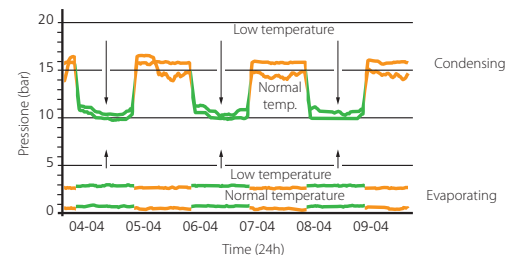
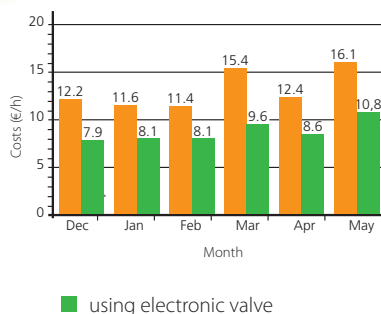

\*\*Measurements carried out in a medium-sized supermarket on showcases and compressor racks operating on R404A. The data incorporate the optimisation of the compressor rack with floating condensing and evaporation pressure, the use of E<sup>V</sup> valves and the control of anti-sweat heaters with temperature and humidity monitoring. Part of the data (floating condensing pressure control with E<sup>V</sup> valves) are also the result of CAREL analysis and case studies supported by the CNR (National Research Centre) and presented during the IIR conference "Energetic performance of different expansion valves in a supermarket" (Vicenza, 2005).

# E<sup>X</sup>V sistema sizing example

Below is an example of sizing the E<sup>X</sup>V valves according to the specified typical conditions in air-conditioning and centralised refrigeration applications. For further information, see the instruction

sheet available at [www.carel.com](http://www.carel.com) (code +050001225).

The values in the tables correspond to around 80% of the maximum effective

cooling capacity. The total refrigerant pressure drop in the high and low pressure branches has been assumed to be no higher than 2 to 3 bars.

## Air-conditioning

### Operating conditions

Saturated condensing temperature: 38 °C  
Saturated evaporation temperature: 4.4 °C  
Subcooling: 1 K

### Rated cooling capacity (kW)

| Valve model | R22    | R134A  | R407C  | R410A  |
|-------------|--------|--------|--------|--------|
| E2V05B      | 1.5    | 1.15   | 1.55   | 1.8    |
| E2V09B      | 2.6    | 2.0    | 2.7    | 3.1    |
| E2V11B      | 4.5    | 3.4    | 4.6    | 5.4    |
| E2V14B      | 6.8    | 5.3    | 7.0    | 8.3    |
| E2V18B      | 9.9    | 7.6    | 10.2   | 11.9   |
| E2V24B      | 18.6   | 14.9   | 20.0   | 23.4   |
| E2V30B      | 31.2   | 24.0   | 32.0   | 37.5   |
| E2V35B      | 39.0   | 30.5   | 40.9   | 47.8   |
| E3V45A      | 69.0   | 53.0   | 71.0   | 83.0   |
| E3V55A      | 100.0  | 76.0   | 102.0  | 120.0  |
| E3V65A      | 140.0  | 107.0  | 143.0  | 167.0  |
| E4V85A      | 195.0  | 149.0  | 200.0  | 234.0  |
| E4V95A      | 270.0  | 208.0  | 280.0  | -      |
| E6VB2A      | 800.0  | 610.0  | 815.0  | 958.0  |
| E5VA5A      | 500    | 375    | 510    | 600    |
| E7VC1A      | 1700.0 | 1280.0 | 1750.0 | 2050.0 |

## Centralised refrigeration

### Operating conditions

Saturated condensing temperature: 38 °C  
Saturated evaporation temperature: -30 °C  
Subcooling: 1 K

### Rated cooling capacity (kW)

| Valve model | R404A | R507a |
|-------------|-------|-------|
| E2V05B      | 1.1   | 1.1   |
| E2V09B      | 1.9   | 1.8   |
| E2V11B      | 3.4   | 3.3   |
| E2V14B      | 5.1   | 5.0   |
| E2V18B      | 7.4   | 7.2   |
| E2V24B      | 14.5  | 14.2  |
| E2V30B      | 23.4  | 22.7  |
| E2V35B      | 29.0  | 28.8  |

## Headquarters ITALY

**CAREL INDUSTRIES HQs**  
Via dell'Industria, 11  
35020 Brugine - Padova (Italy)  
Tel. (+39) 0499 716611  
Fax (+39) 0499 716600  
[carel@carel.com](mailto:carel@carel.com)

## Sales organization

**CAREL Asia**  
[www.carel.com](http://www.carel.com)

**CAREL Australia**  
[www.carel.com.au](http://www.carel.com.au)

**CAREL China**  
[www.carel-china.com](http://www.carel-china.com)

**CAREL Deutschland**  
[www.carel.de](http://www.carel.de)

**CAREL France**  
[www.carelfrence.fr](http://www.carelfrence.fr)

**CAREL Iberica**  
[www.carel.es](http://www.carel.es)

**CAREL India**  
[www.carel.in](http://www.carel.in)

**CAREL HVAC/R Korea**  
[www.carel.com](http://www.carel.com)

**CAREL Russia**  
[www.carelrussia.com](http://www.carelrussia.com)

**CAREL South Africa**  
[www.carelcontrols.co.za](http://www.carelcontrols.co.za)

**CAREL Sud America**  
[www.carel.com.br](http://www.carel.com.br)

**CAREL U.K.**  
[www.careluuk.co.uk](http://www.careluuk.co.uk)

**CAREL U.S.A.**  
[www.carelusa.com](http://www.carelusa.com)

## Affiliates

**CAREL Czech & Slovakia**  
[www.carel-cz.cz](http://www.carel-cz.cz)

**CAREL Korea (for retail market)**  
[www.carel.co.kr](http://www.carel.co.kr)

**CAREL Ireland**  
[www.carel.com](http://www.carel.com)

**CAREL Thailand**  
[www.carel.co.th](http://www.carel.co.th)

**CAREL Turkey**  
[www.carel.com.tr](http://www.carel.com.tr)